

PARTS

(1) Hardware



(2) Graphic printing fabric banner



(3) LED Light Light Clips



STEP 01

To connect the poles according to the labellings

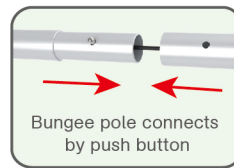

STEP 02

To use corner pieces to connect the poles to be display stand

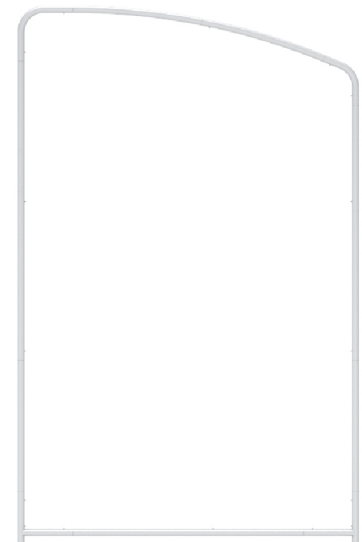
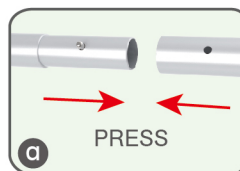
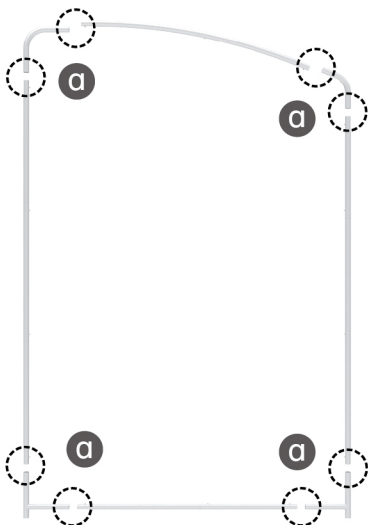

PARTS

STEP 03

To slide the fabric banner on the frame from top and zip up at bottom

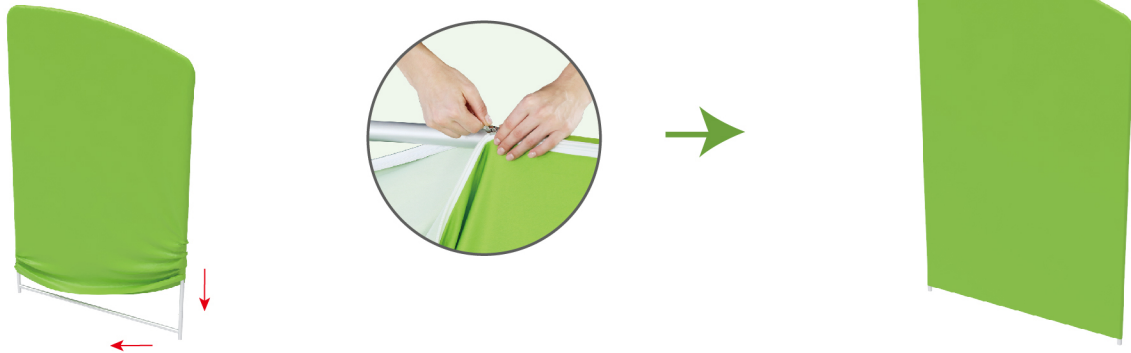

STEP 04

To assemble the stand feet in position

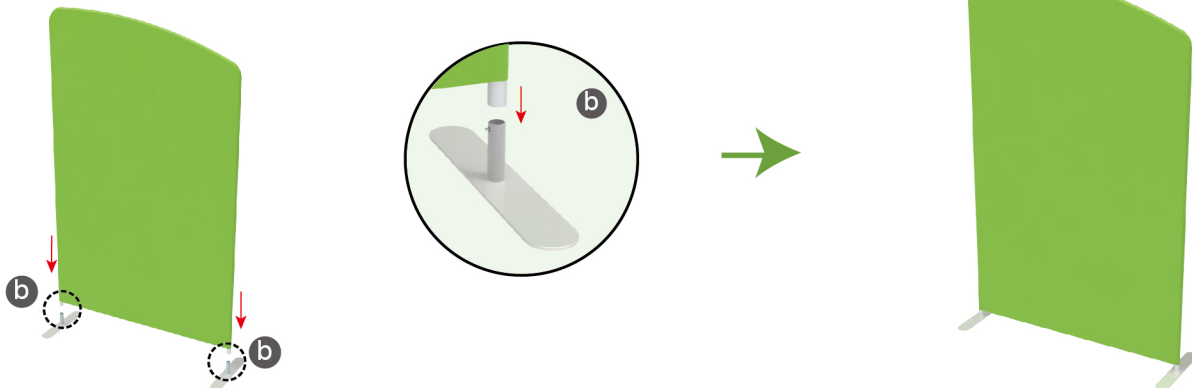

STEP 05

Install LED light

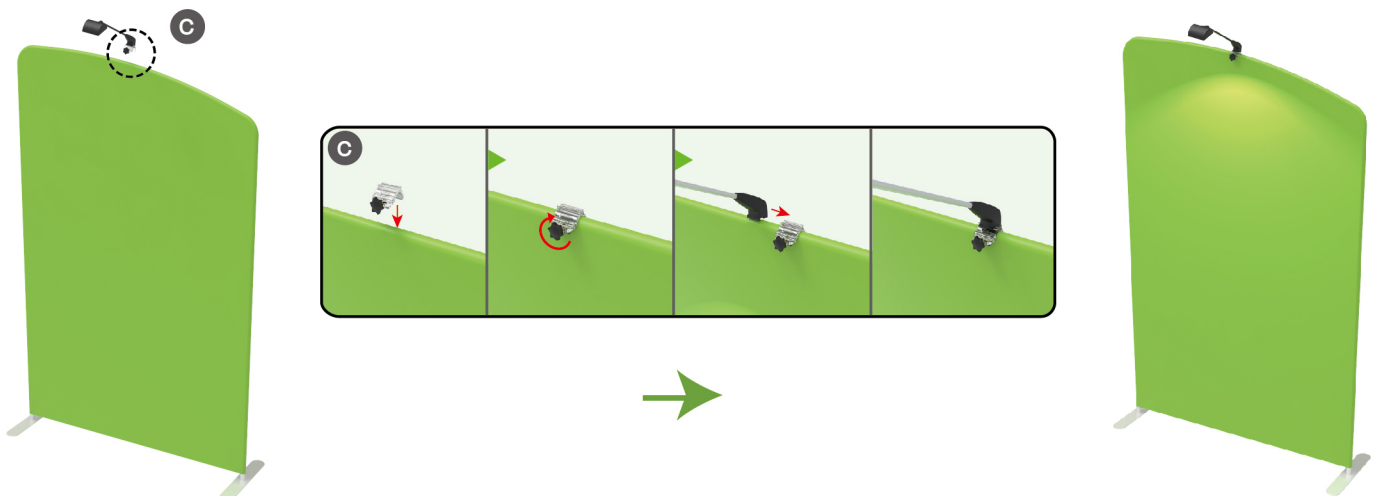

PARTS

(1) Hardware

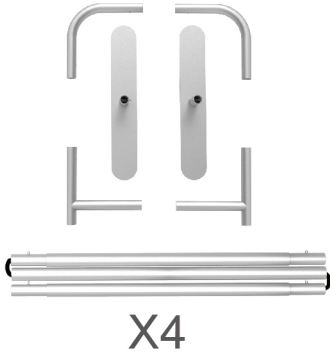

(2) Graphic printing fabric banner



(3) LED Light Light Clips

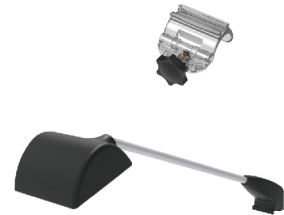

STEP 01

To connect the poles according to the labellings

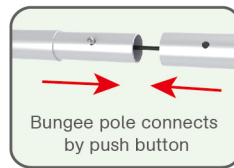

STEP 02

To use corner pieces to connect the poles to be display stand

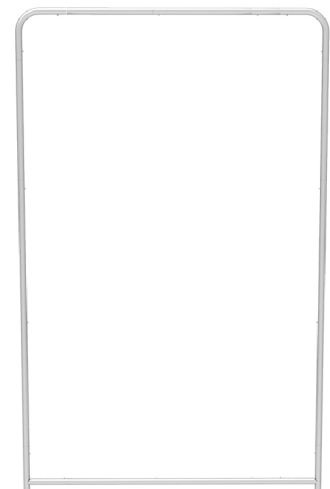
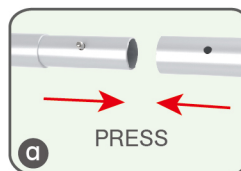
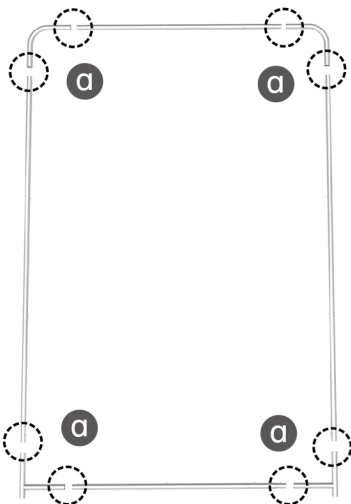

PARTS

STEP 03

To slide the fabric banner on the frame from top and zip up at bottom

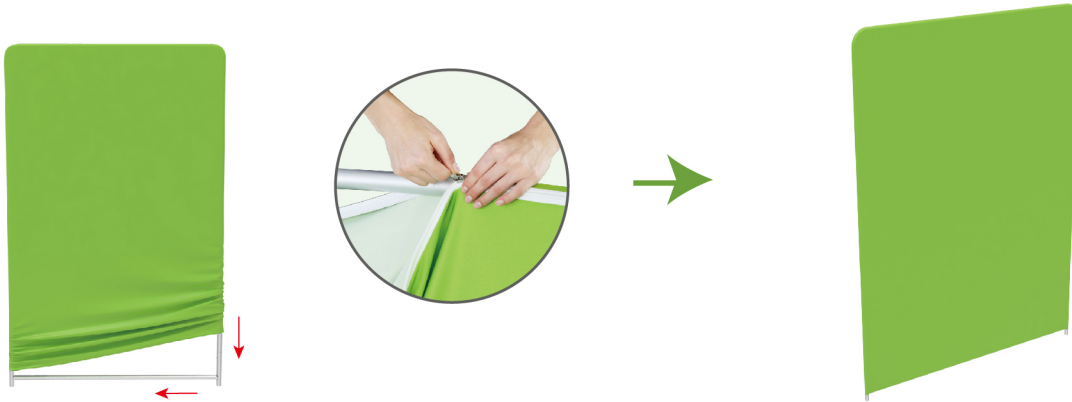

STEP 04

To assemble the stand feet in position

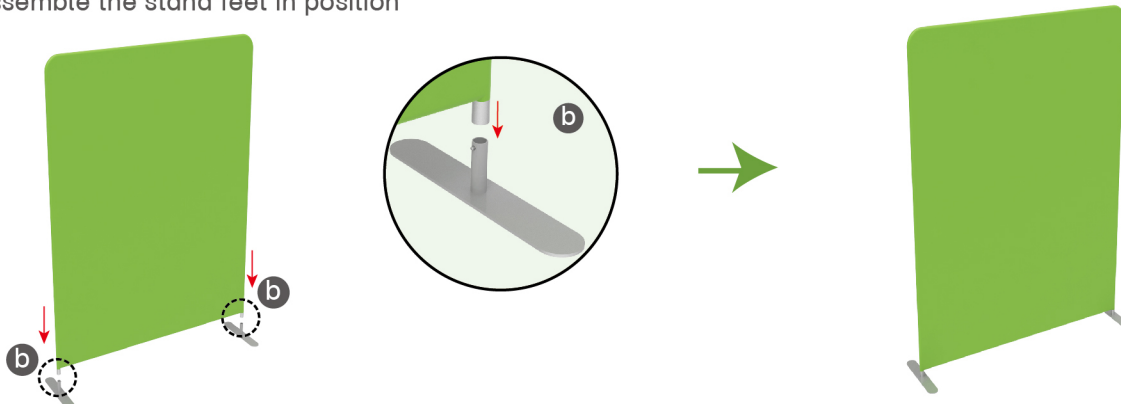

STEP 05

Install LED light

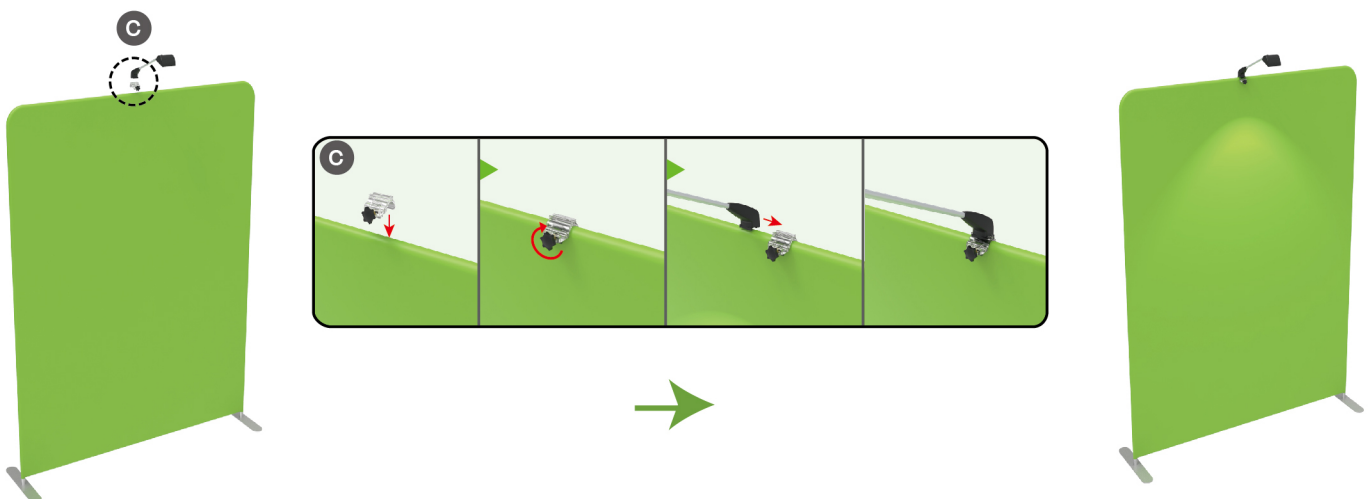

PARTS

(1) Booth Set

C clip x 2
Clamp x 1

1x shelf
1x Upright pole
for shelf

1x TV mount and screw bag
1x Allen Key

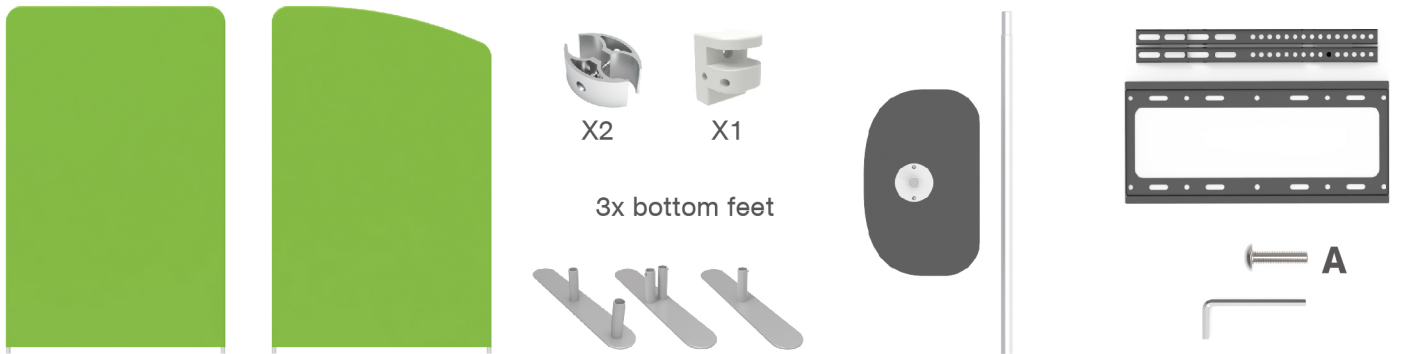

STEP 01

To assemble the stand feet in position

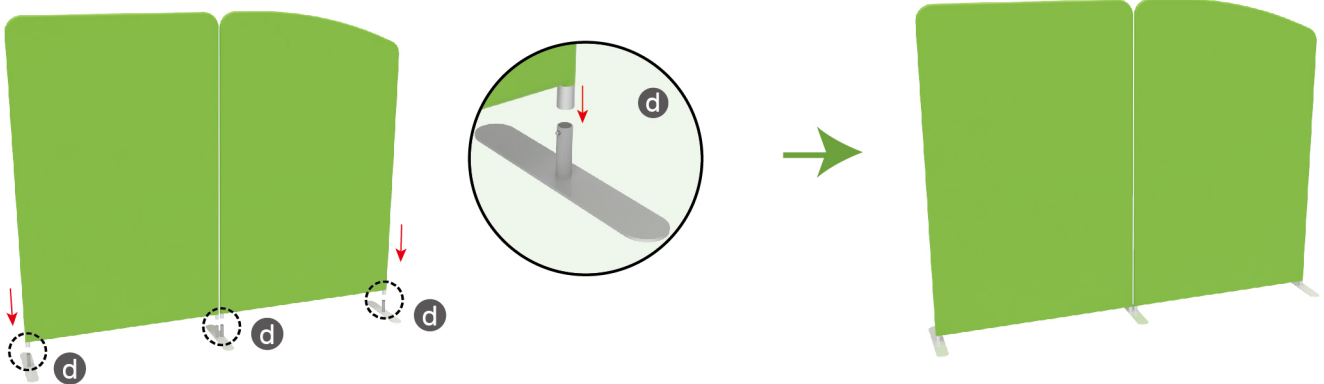

STEP 02

To use C clip to connect 2 display stand perfectly

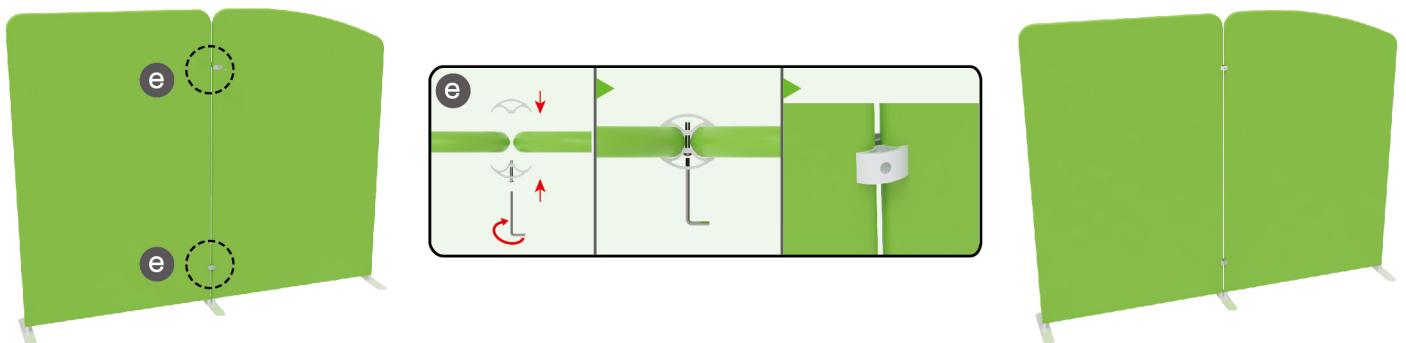

PARTS

STEP 03

To install the shelf in position

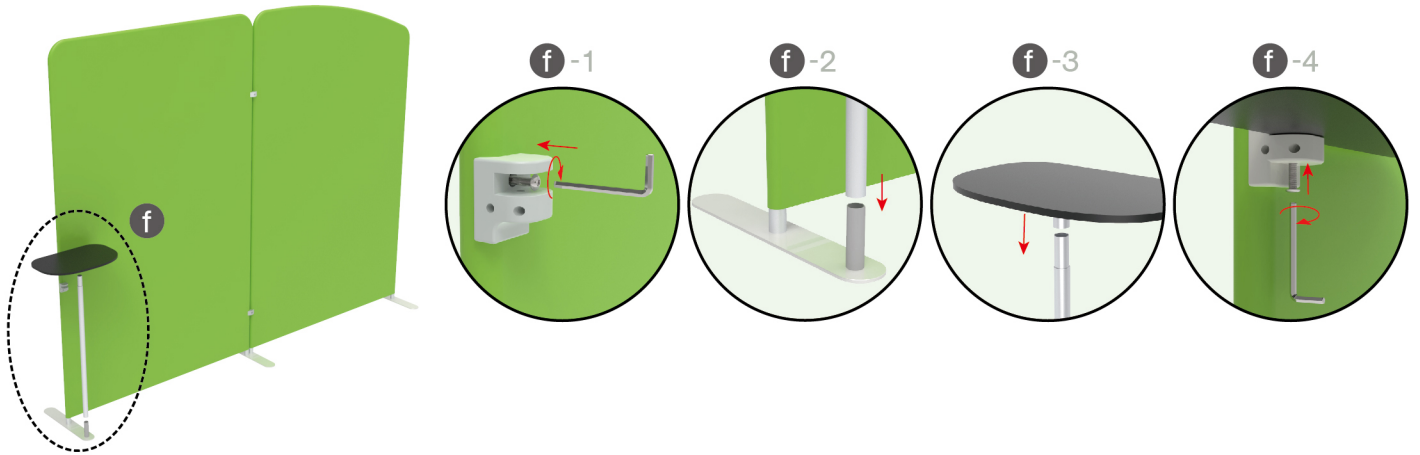

STEP 04

To install the TV mount in position

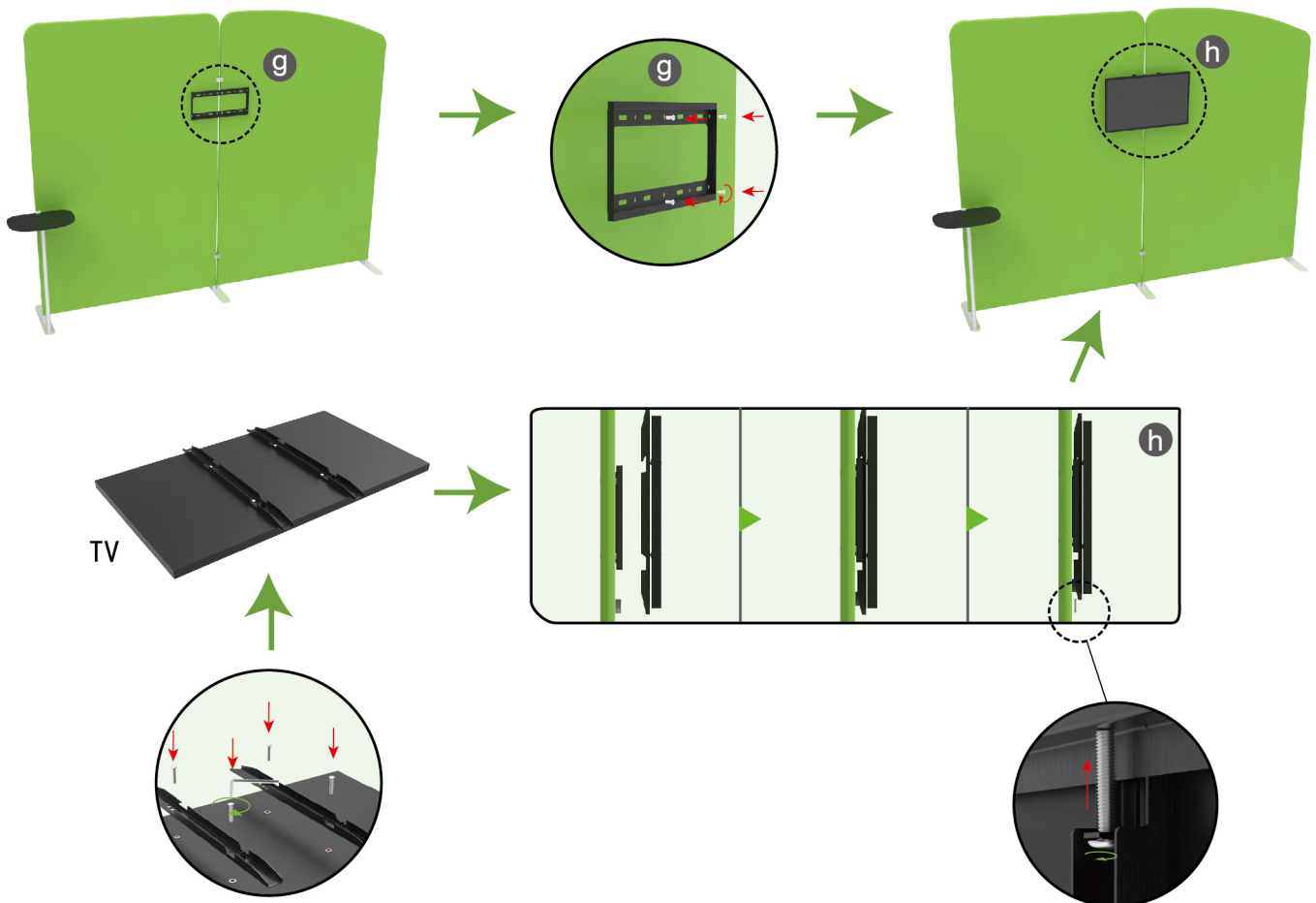

PARTS

Same Assembly Steps for below Booths



10x10FT-BOOTH-A1



10x10FT-BOOTH-B1



10x10FT-BOOTH-03



10x10FT-BOOTH-13