

## PARTS

(1) Hardware

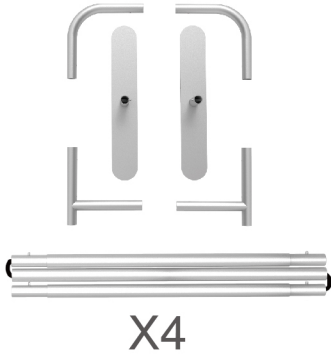

(2) Graphic printing fabric banner



### STEP 01

To connect the poles according to the labellings

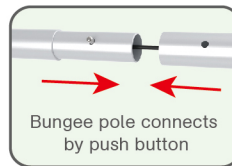
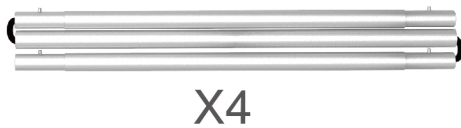

### STEP 02

To use corner pieces to connect the poles to be display stand

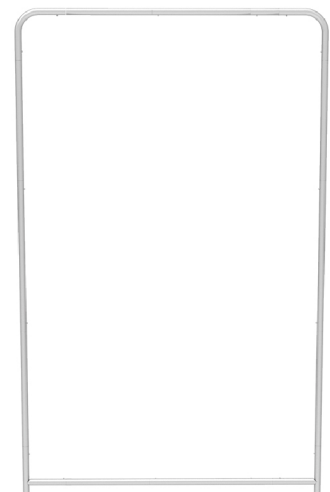
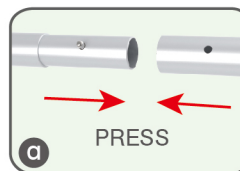
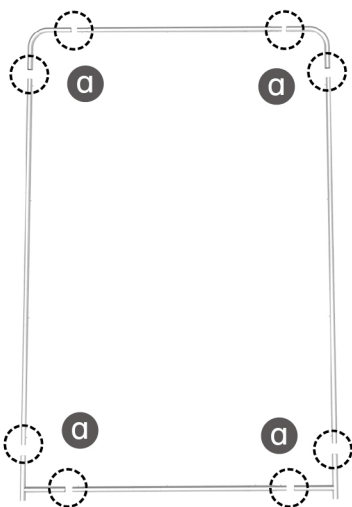

## PARTS

### STEP 03

To slide the fabric banner on the frame from top and zip up at bottom



### STEP 04

To assemble the stand feet in position

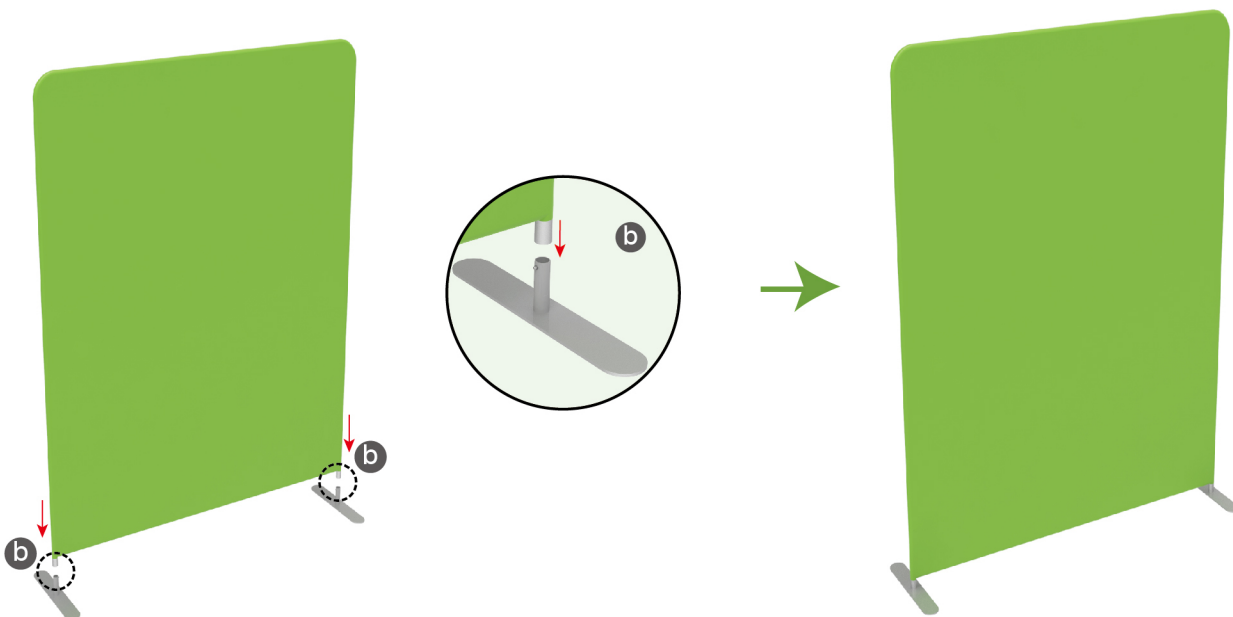

## PARTS

(1) Hardware

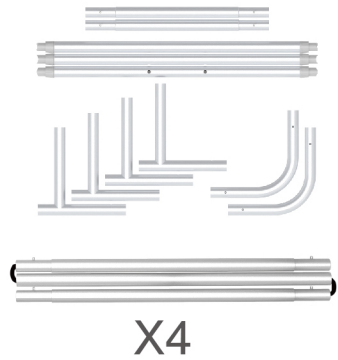

(2) Graphic printing fabric banner



### STEP 01

To connect the poles according to the labellings

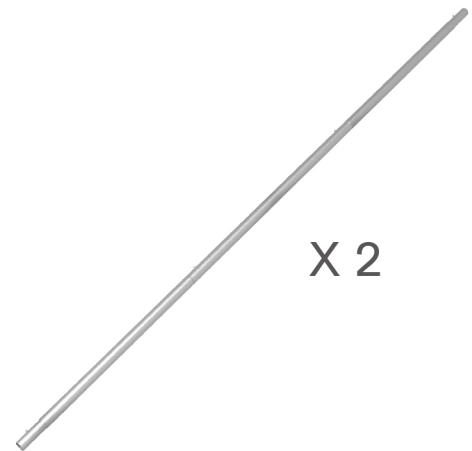
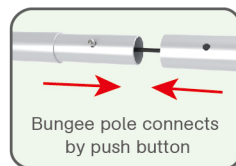
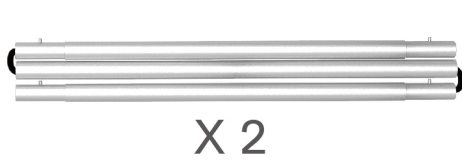

### STEP 02

To use corner pieces to connect the poles to be display stand

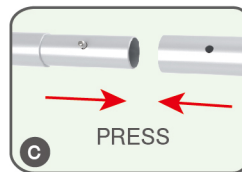
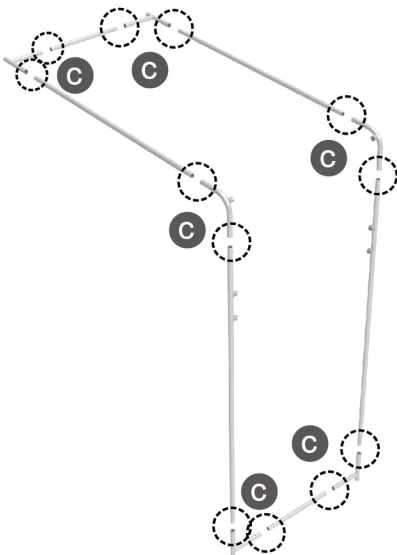

## PARTS

### STEP 03

To install the cross bar according to the labellings

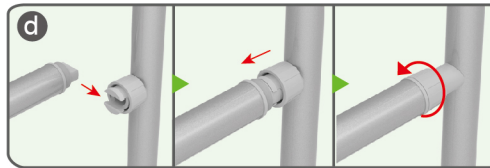
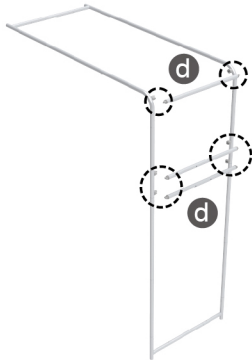

### STEP 04

To Wrap the fabric banner from side to sides and zip up



### STEP 05

To assemble the feet in position

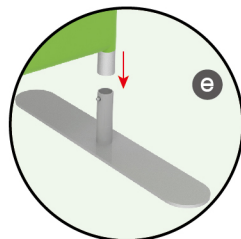
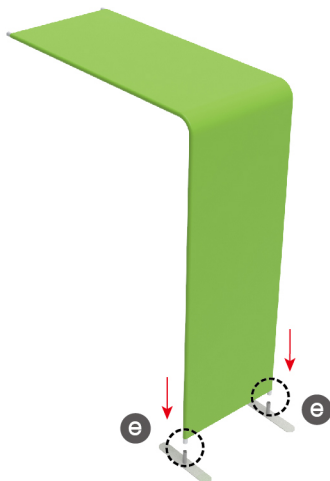

## PARTS

(1) Hardware



(2) Graphic printing fabric banner



### STEP 01

To connect the poles according to the labellings

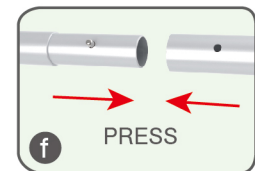
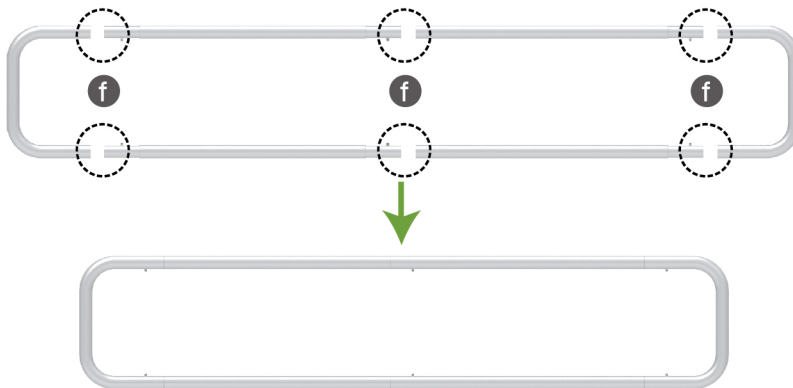

### STEP 02

To wrap up the fabric banner from side to side and zip up

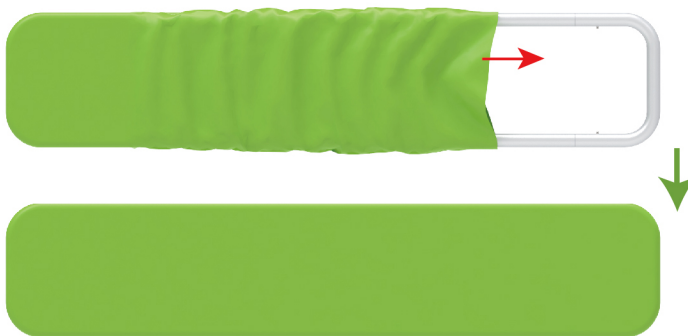

Same steps for below style of headers



## PARTS

(1) Booth Set



### STEP 01

To attach the Arch TV stand to the backwall and fasten the clamp by Allen key

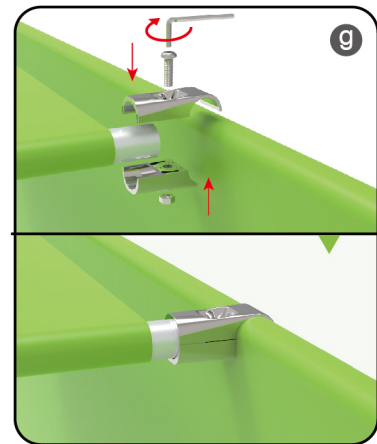

## PARTS

### STEP 02

To use C clip & Allen Key to fasten the header on the backwall

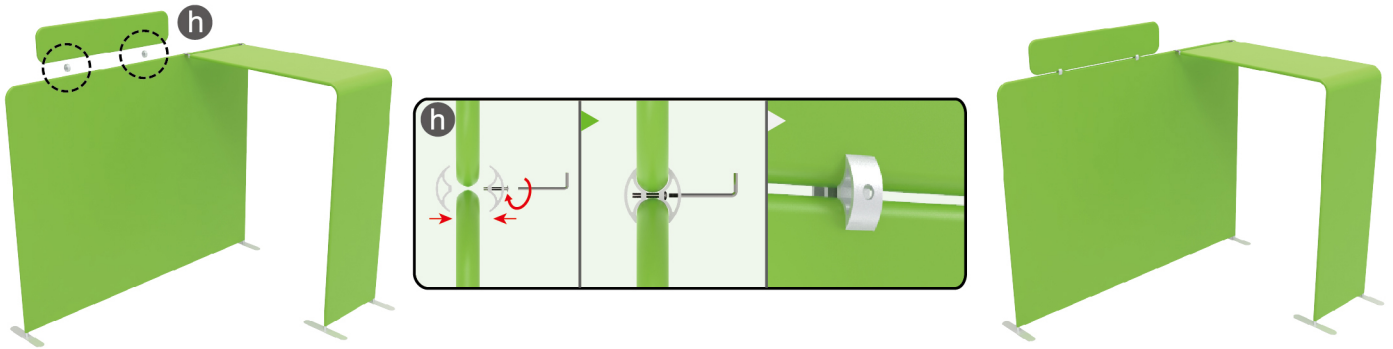

### STEP 04

To install the TV mount in position

TV Mount with screw bag x 1  
Allen Key x 1

