

INSTRUCTION

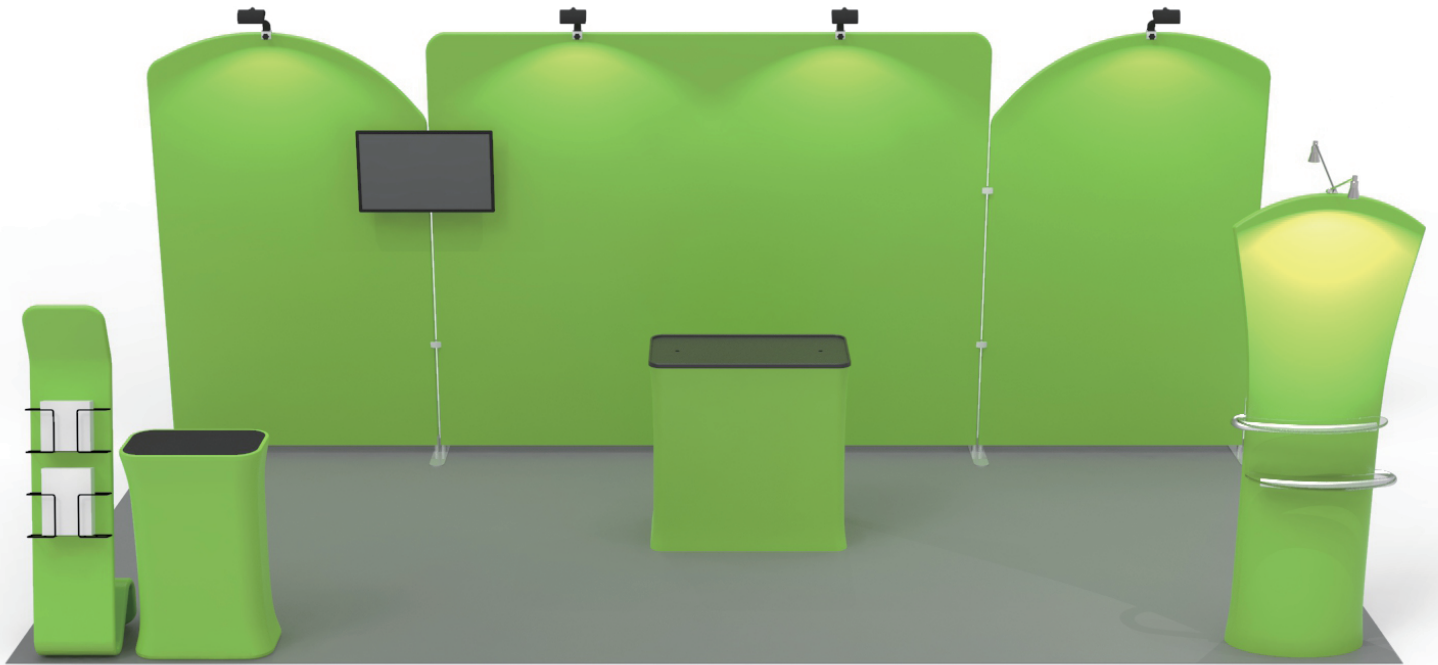

10X20FT-BOOTH-J

STEPS

(1) Hardware

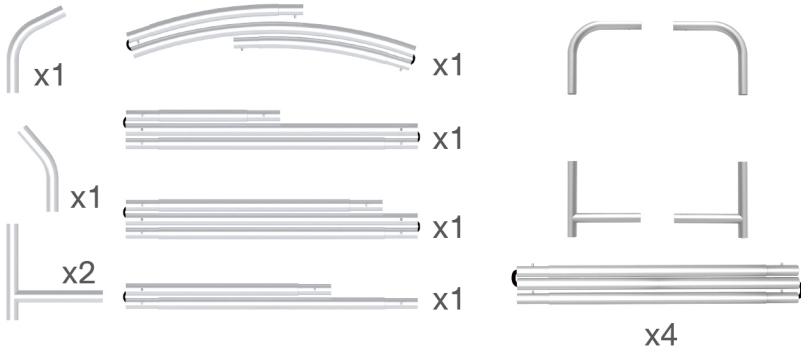

(2) Printed Graphic Fabric Banner (Optional)



STEP 01

Connect to make long poles according to labelings.

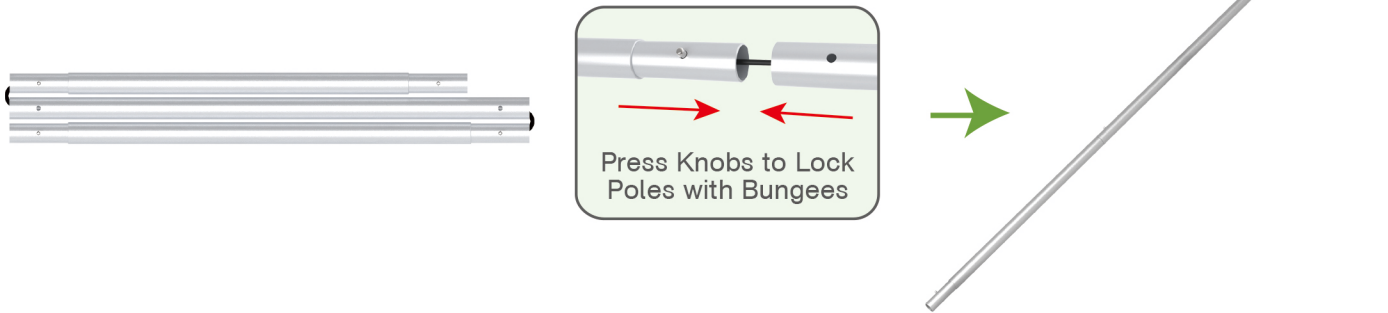

STEP 02

Connect long poles with corner poles according to labelings.

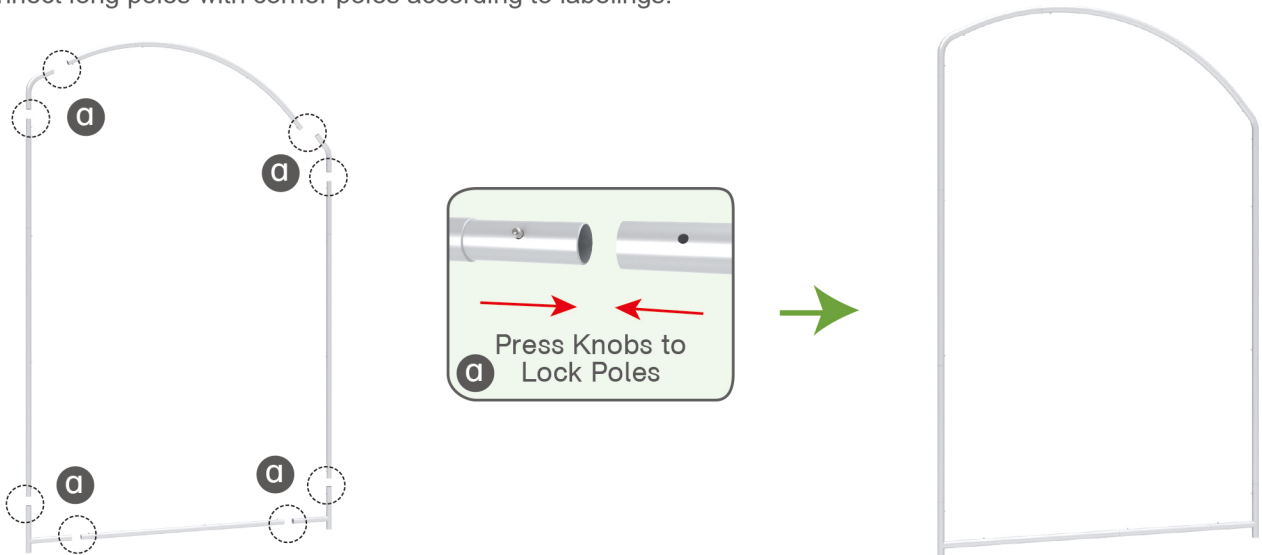

STEPS

STEP 03

Slide fabric banner on frame from top and zip up at bottom.



Same steps for rest back walls

Booth Set Assembly

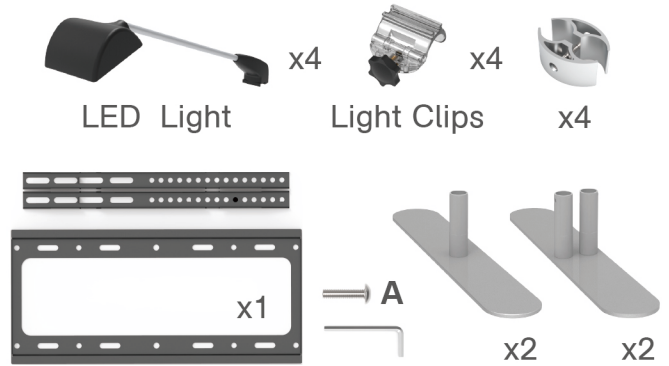

STEP 01

Insert display stands onto feet by pressing their knobs.

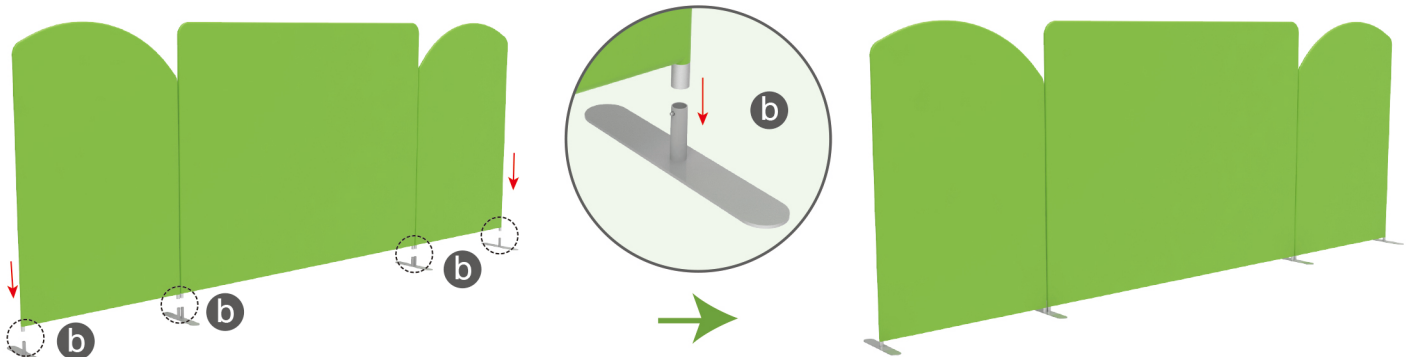

STEPS

STEP 02

Interconnect display stands with C-shaped clips.

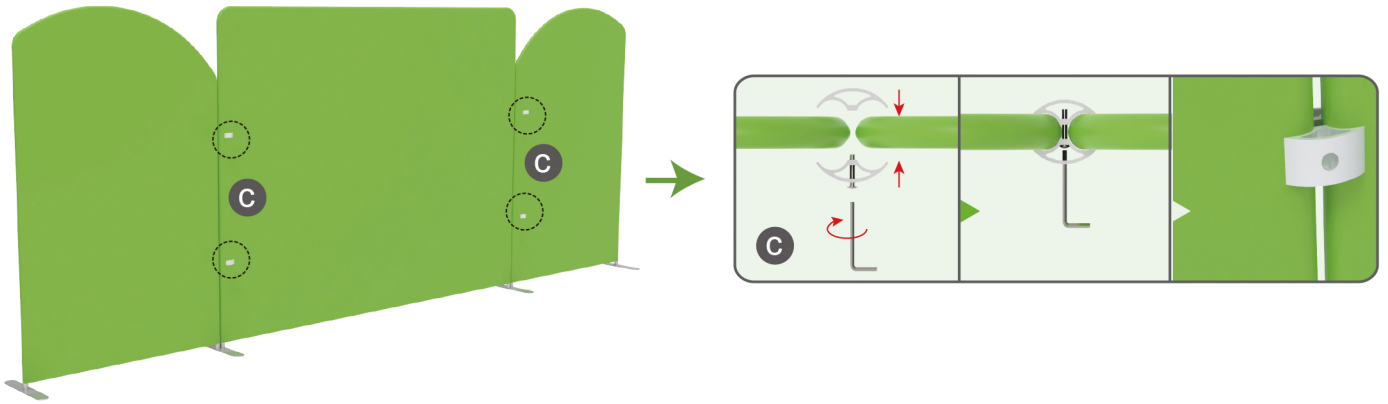

STEP 03

Screw TV mount with hex wrench.

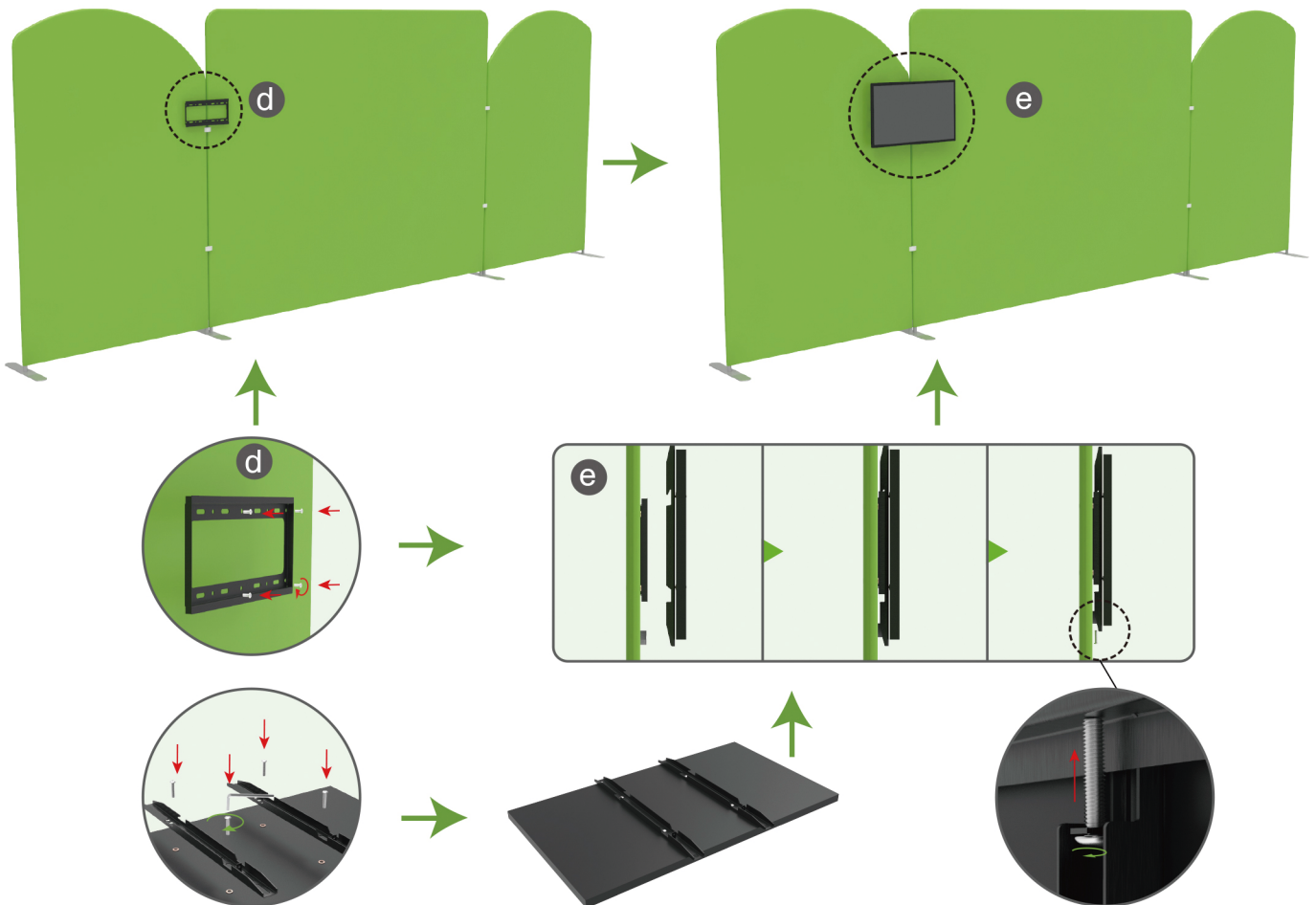

STEPS

STEP 04

Screw light clips at top of display stands, slide lights onto them and adjust their direction.

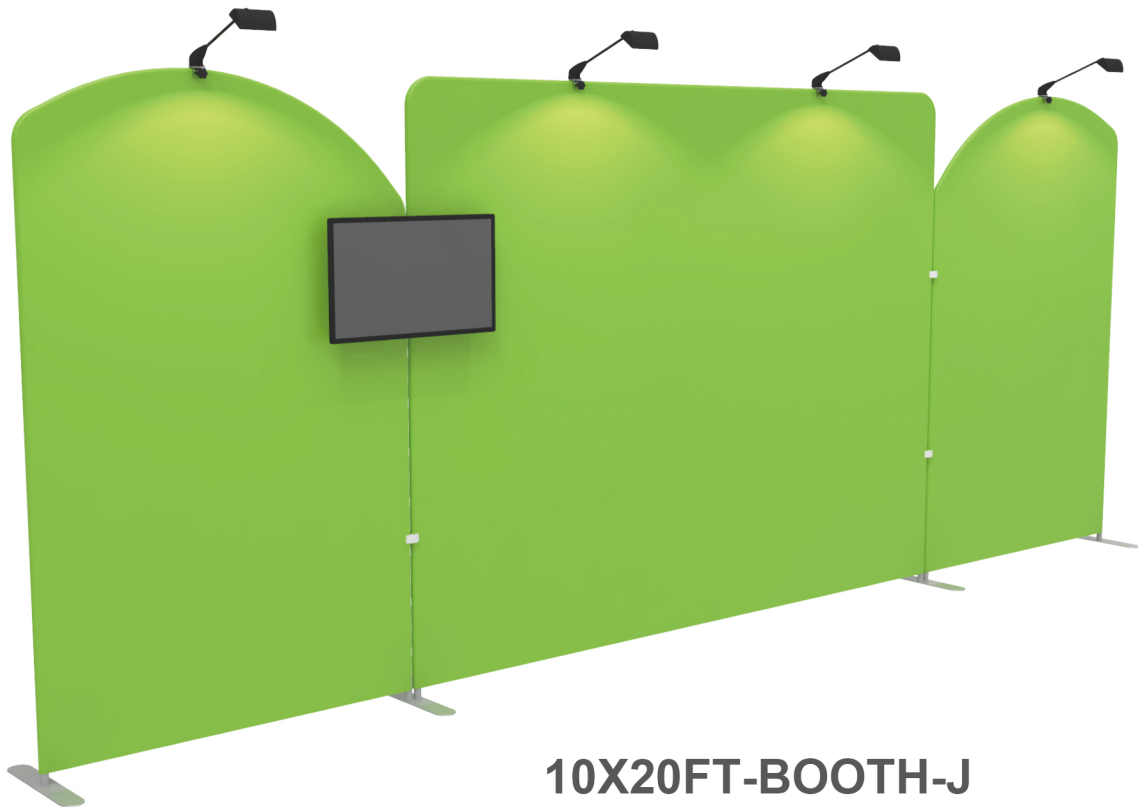
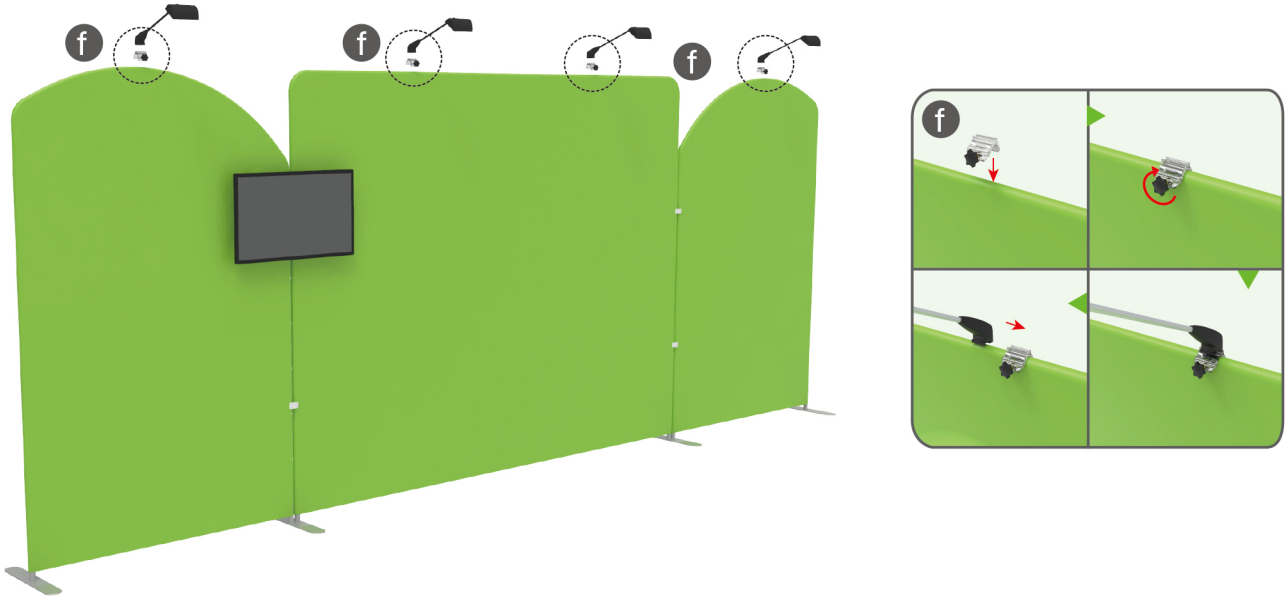

10X20FT-BOOTH-J

STEPS

(1) Durable Plastic Hard Case, Aluminum Support Poles



(2) Printed Graphic Fabric Banner



STEP 01

Put hard case's top into fabric banner.

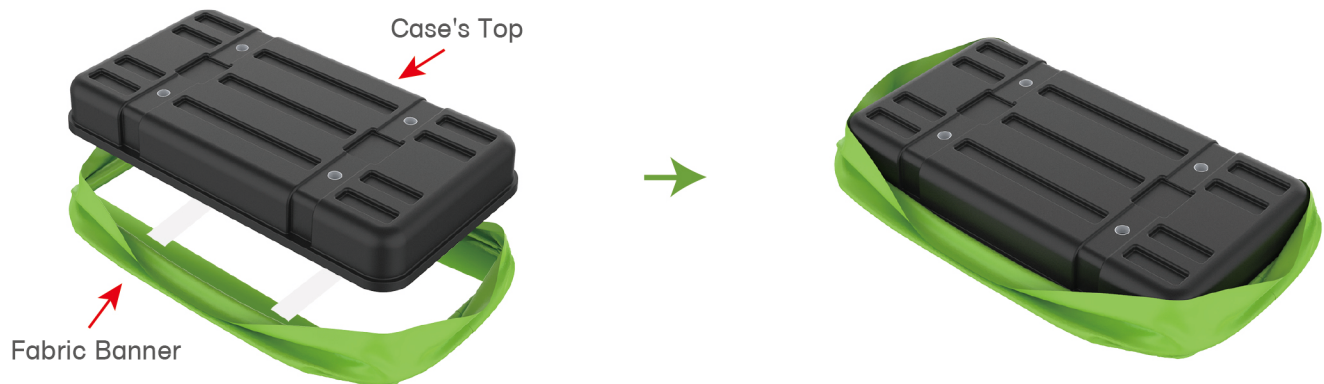

STEP 02

Insert support poles into hard case's top & bottom.

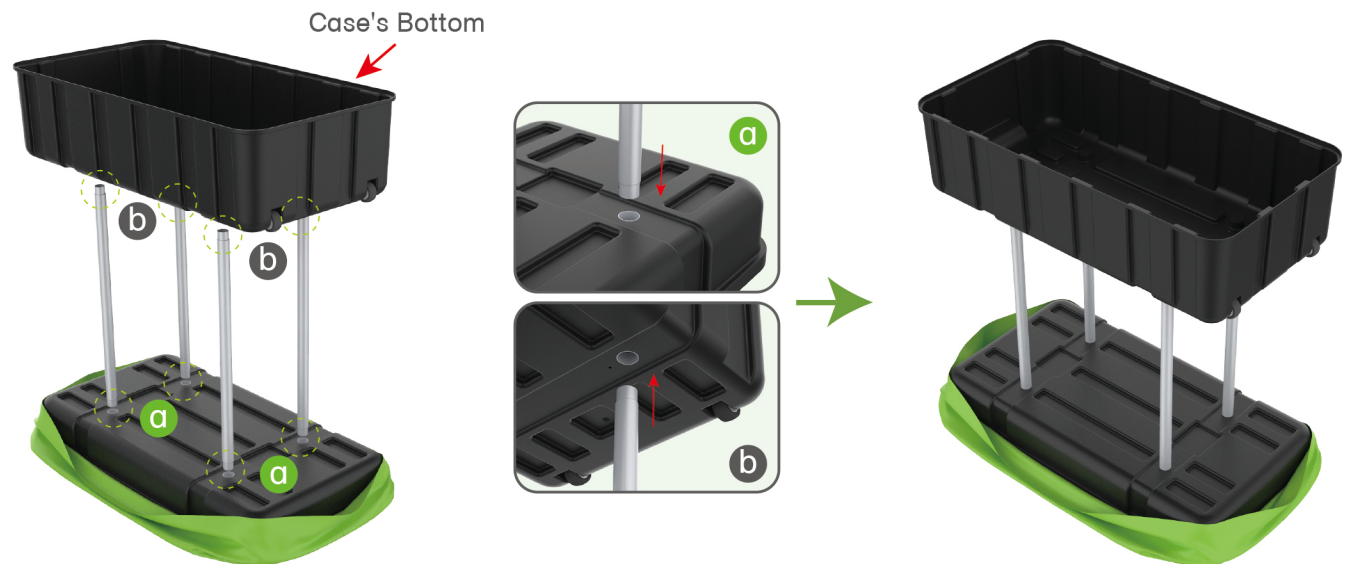

STEPS

STEP 04

Wrap fabric banner from bottom to top & twist it to be smooth, lay hard case's intermediate panel on podium's top.

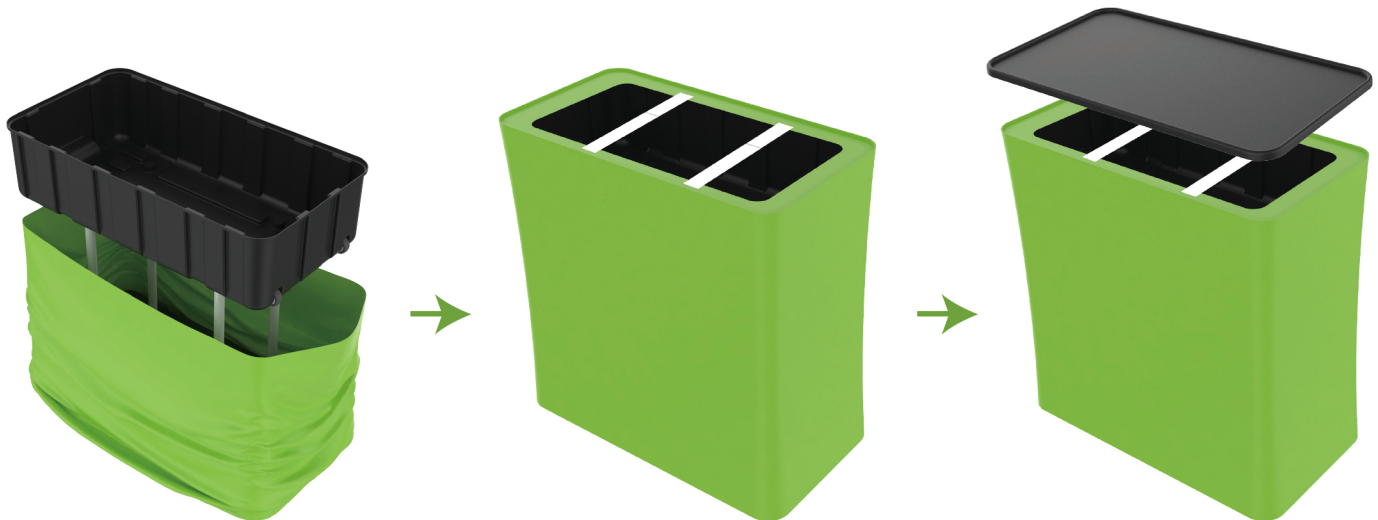

STEPS

(1) Snap Tubes

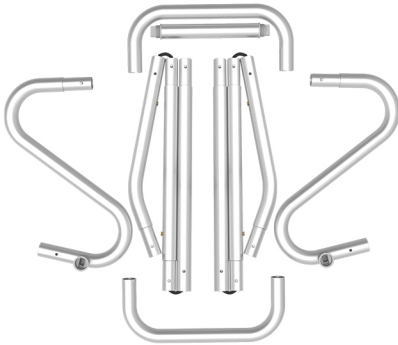

(2) Printed fabric banner



(3) Brochure rack x 2
Screws x 4

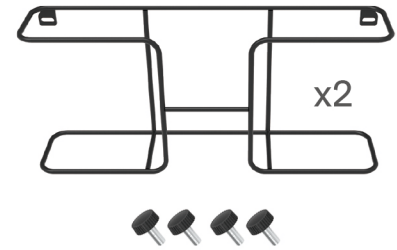

STEP 01

To Connect the tubes according to the labellings

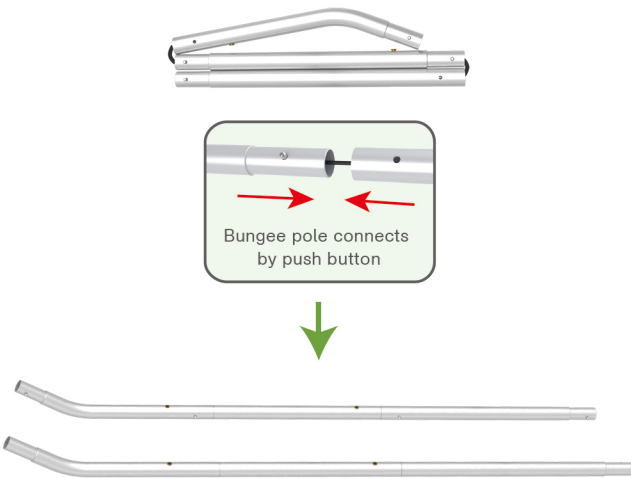

STEP 02

To connect 2 long side tubes by the corner pieces

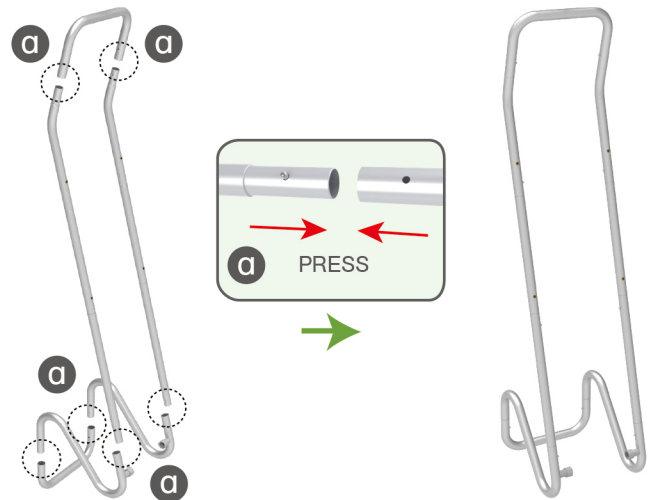

STEP 03

To install the cross bar according to labellings

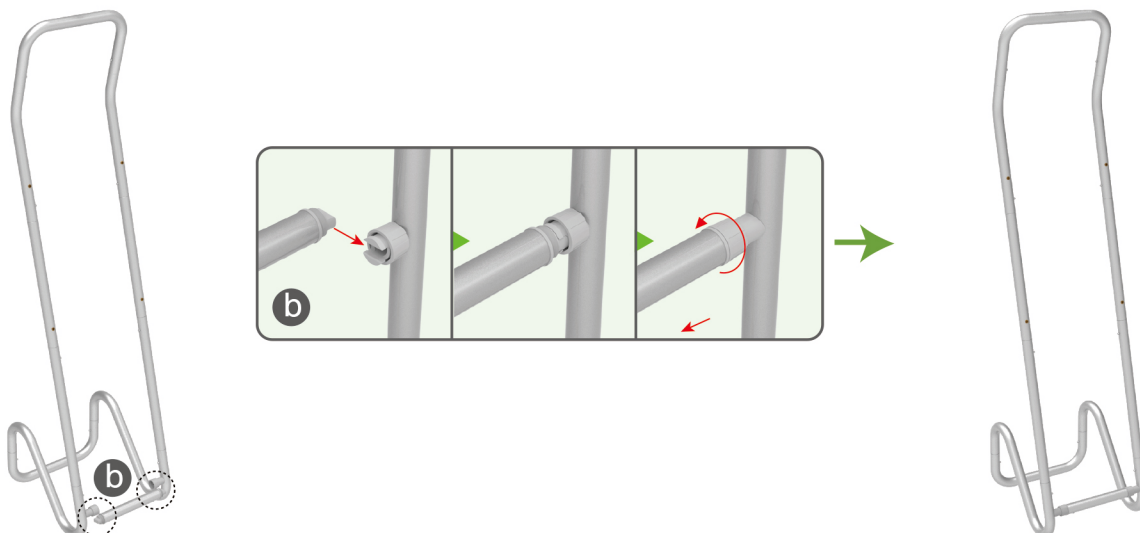

STEPS

STEP 04

To Wrap up the fabric banner from top to bottom and zip up.

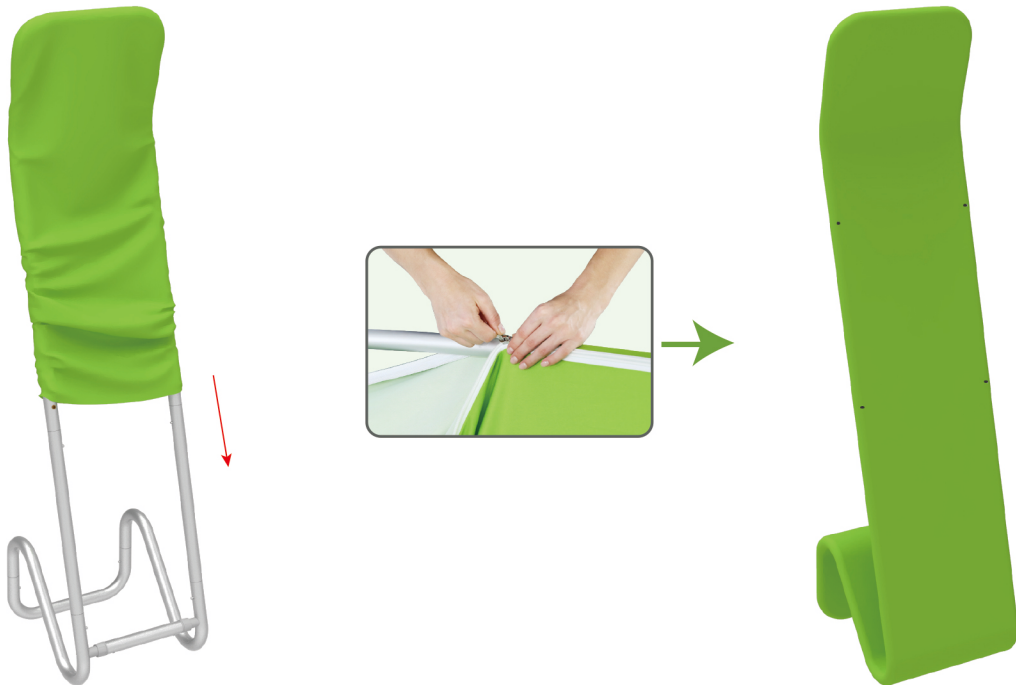

STEP 05

To install 2 racks by screws in position

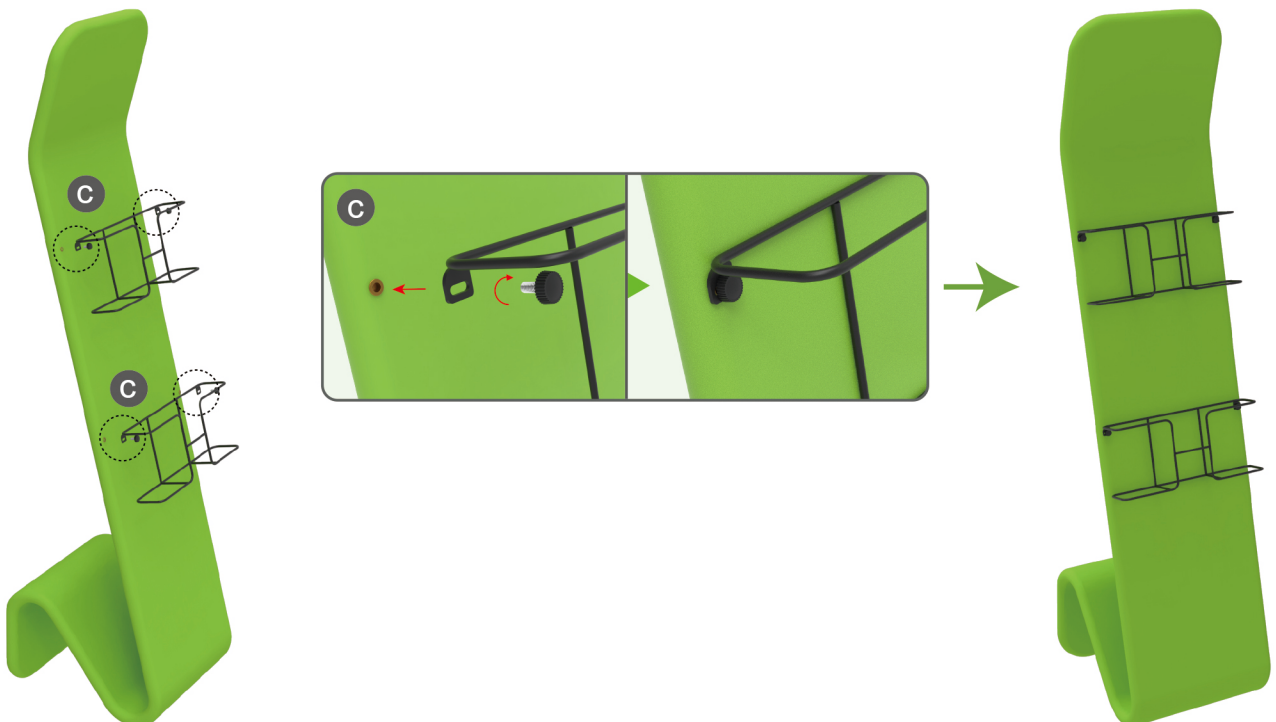

★ One Tool (Hex Wrench) 

STEPS

(1) Aluminum pole



(2) MDF panel



(3) Fabric banner



(4) Optional Accessory



STEP 01

To assemble the poles according to labelling

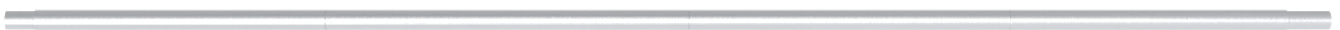
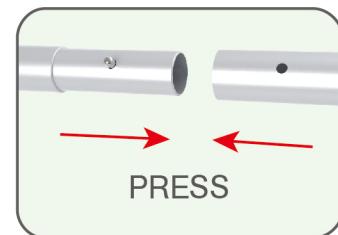

STEPS

STEP 02

To put the bottom MDF panel upside down and clip the fabric banner to the slot

To put the middle of fabric bottom into the middle of bottom panel slot and start the assembly



BOTTOM



PRESS

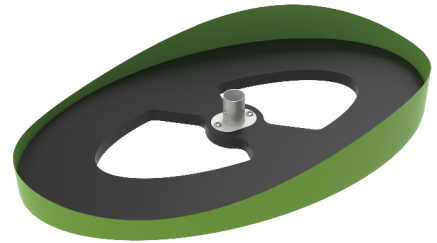

STEP 03

Insert the center pole into the base.

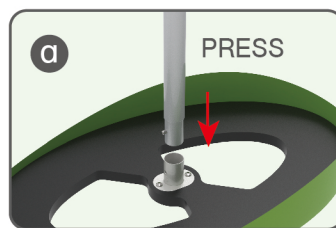
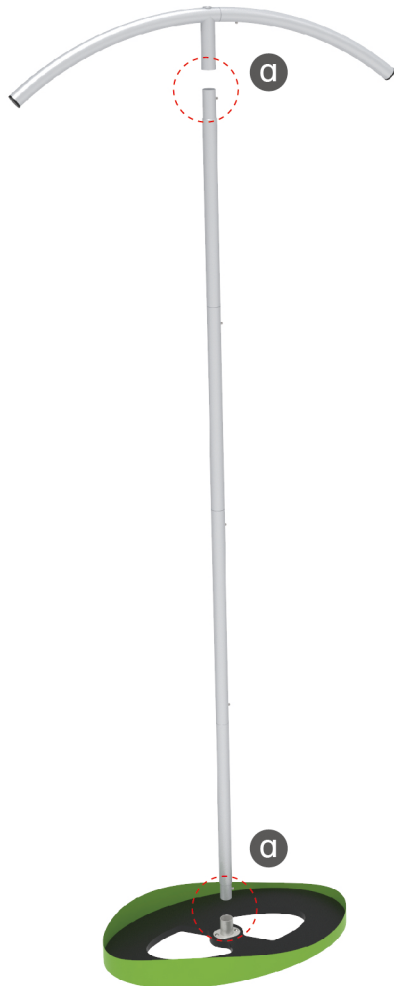

STEPS

STEP 04

Stretch the cloth cover upward and put it into the top bracket. Pull the zipper on both sides to the middle to expose the hole of the LED light on the top of the bracket

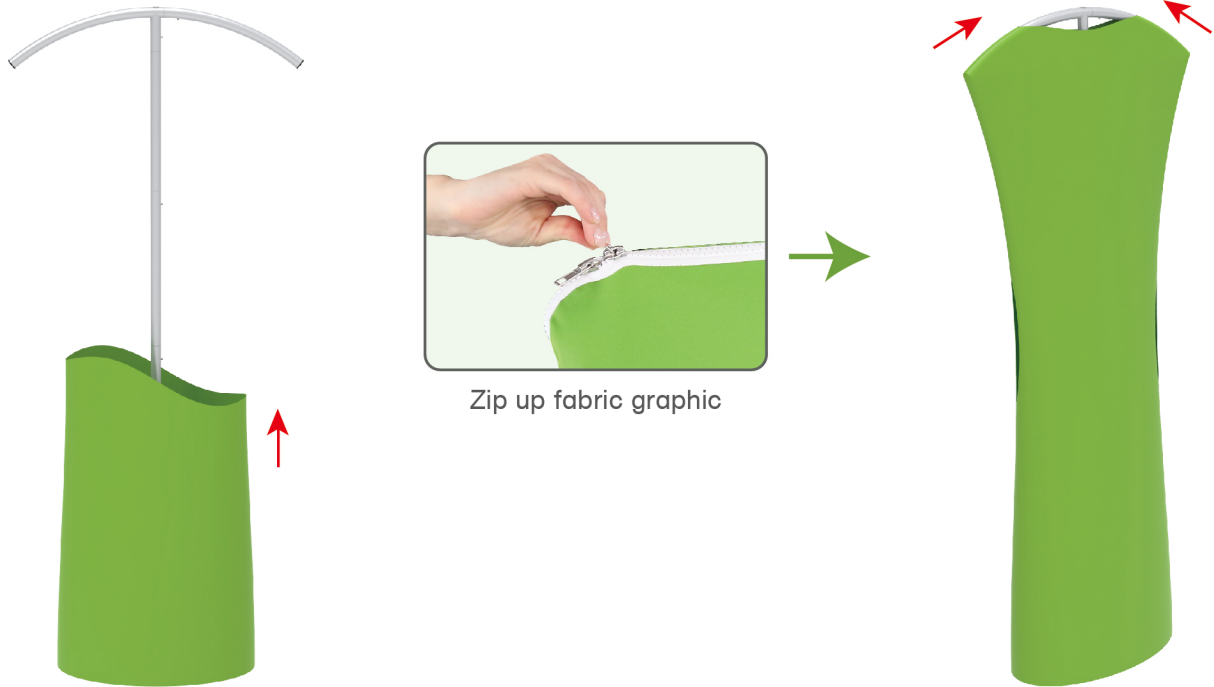

STEP 05

Slide the shelves through the open slits in the graphic and connect them to their support sockets.

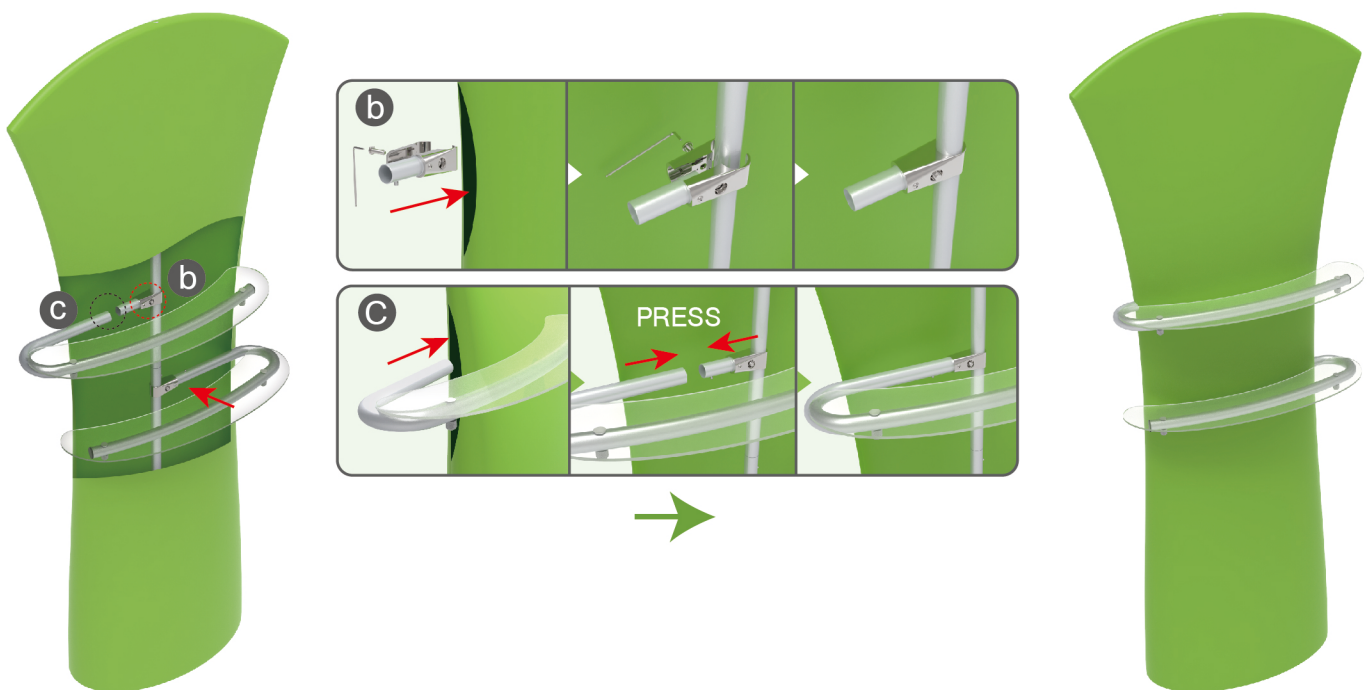

STEPS

STEP 06

Place the base of the light fitting in the hole in the middle of the profile.

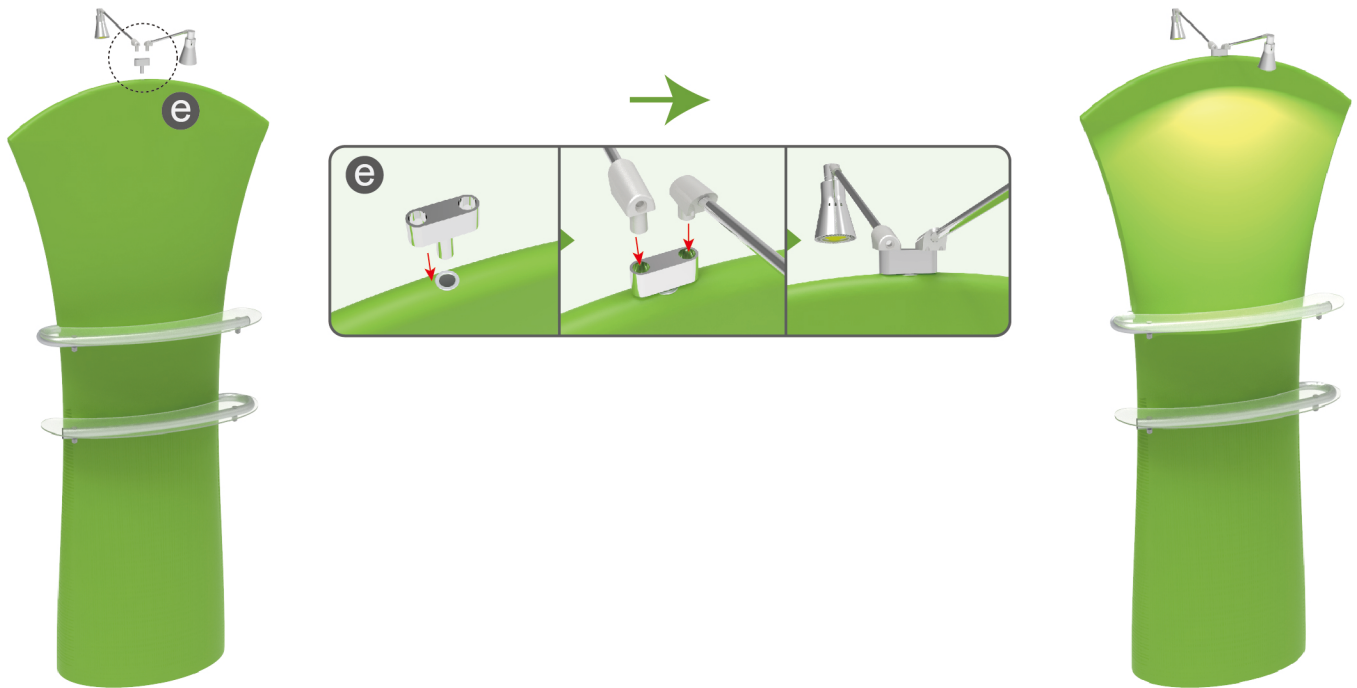

DT-W-01



DT-W-02



DT-W-03

STEPS

(1) Straight Support Poles

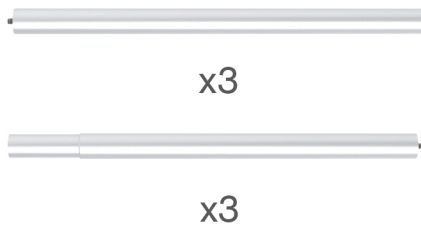

(2) Top MDF Board
Bottom MDF Board

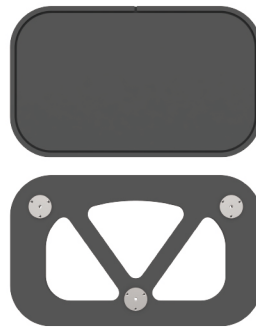

(3) Printed Graphic Fabric Banner



STEP 01

Insert fabric banner into bottom MDF board's slot and turn it over.



STEP 02

Screw straight support poles in top & bottom MDF boards' threaded holes and interconnect them in the middle.

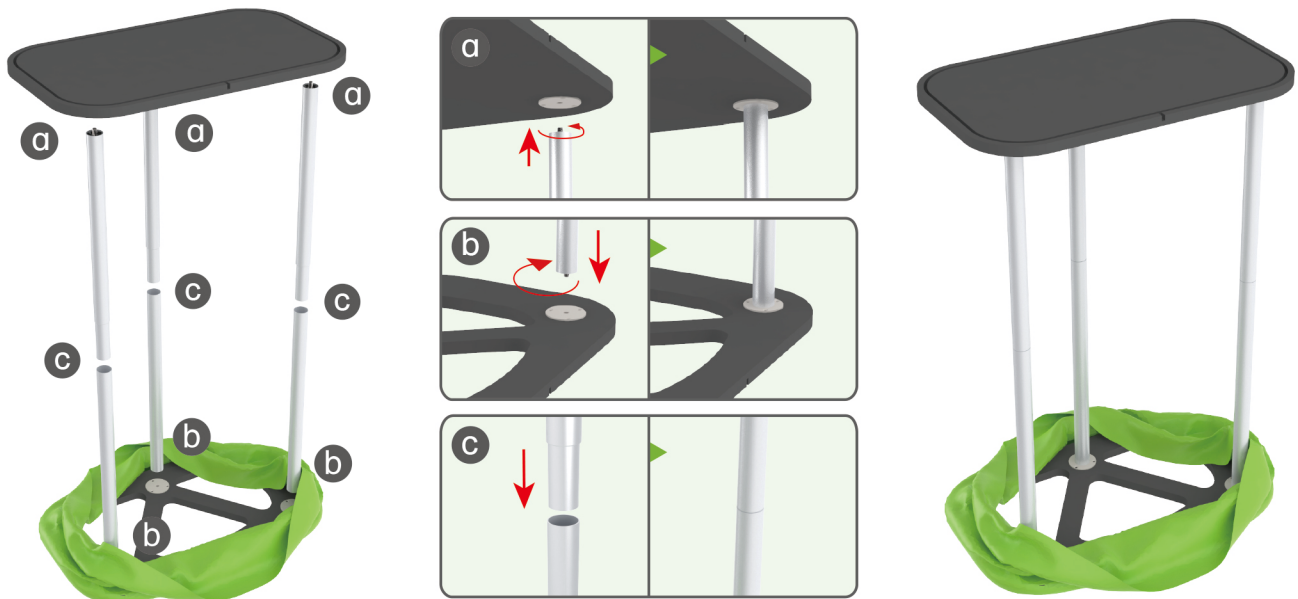

STEP 03

Pull fabric banner from bottom to top and insert into top MDF board's slot.



PRESS



DT-C-03



DT-C-01



DT-C-02